

# reversible pump - series XV

# XV-2R

STANDARD EUROPEAN PUMP  
 ø36.5 FLANGE - TAPER SHAFT

**X 2 R 51 01 E P P E**

Series	X	series XV
Group	2	group 2
Category	R	reversible pump
Displacement	51	17
Flange	01	Ø36.5 STANDARD EUROPEAN reversible rotation
Shaft	E	CO001 - Tapered 1:8 - ø17.4 - M12x1.5 - key thk.4
Body	IN	inlet - Ø40 Ø20 M8
	OUT	outlet - Ø40 Ø20 M8
Cover	E	with external drainage

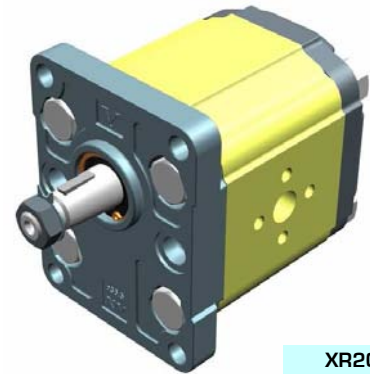

XR201

Technical data table

TYPE	Displacement cm3/rev	Max. Pressure		CODE																	
		P1 bar	P3 bar	External drainage				Internal drainage													
XV-2R/04	4,20	260	300	X	2	R	41	01	E	00	E	X	2	R	41	01	E	00	F		
XV-2R/06	6,00	260	300	X	2	R	43	01	E	00	E	X	2	R	43	01	E	00	F		
XV-2R/09	8,40	260	300	X	2	R	45	01	E	00	E	X	2	R	45	01	E	00	F		
XV-2R/11	10,80	260	300	X	2	R	47	01	E	00	E	X	2	R	47	01	E	00	F		
XV-2R/14	14,40	250	290	X	2	R	49	01	E	P	P	E	X	2	R	49	01	E	P	P	F
XV-2R/17	16,80	230	270	X	2	R	51	01	E	P	P	E	X	2	R	51	01	E	P	P	F
XV-2R/19	19,20	210	250	X	2	R	53	01	E	P	P	E	X	2	R	53	01	E	P	P	F
XV-2R/22	22,80	200	240	X	2	R	55	01	E	P	P	E	X	2	R	55	01	E	P	P	F
XV-2R/26	26,20	170	210	X	2	R	57	01	E	Q	P	E	X	2	R	57	01	E	Q	P	F
XV-2R/30	30,00	160	200	X	2	R	59	01	E	Q	P	E	X	2	R	59	01	E	Q	P	F
XV-2R/34	34,20	150	190	X	2	R	61	01	E	Q	P	E	X	2	R	61	01	E	Q	P	F
XV-2R/40	39,60	140	180	X	2	R	63	01	E	Q	P	E	X	2	R	63	01	E	Q	P	F

P1) Max. working pressure - P3) Max. peak pressure

For heavy-duty applications, it is recommended to check the admissible torque of the shaft

Dimensions table

TYPE	Weight kg	A	B	C	D	E	F	D	E	F
		mm	mm	mm	IN			OUT		
XV-2R/04	2,200	87,2	41,7	77,2	ø13,5	30	M6x1	ø13,5	30	M6x1
XV-2R/06	2,300	90,2	43,2	80,2	ø13,5	30	M6x1	ø13,5	30	M6x1
XV-2R/09	2,400	94,2	45,2	84,2	ø13,5	30	M6x1	ø13,5	30	M6x1
XV-2R/11	2,500	98,2	47,2	88,2	ø13,5	30	M6x1	ø13,5	30	M6x1
XV-2R/14	2,700	104,2	50,2	94,2	ø20	40	M8X1,25	ø20	40	M8X1,25
XV-2R/17	2,800	108,2	52,2	98,2	ø20	40	M8X1,25	ø20	40	M8X1,25
XV-2R/19	2,900	112,2	54,2	102,2	ø20	40	M8X1,25	ø20	40	M8X1,25
XV-2R/22	3,050	118,2	57,2	108,2	ø20	40	M8X1,25	ø20	40	M8X1,25
XV-2R/26	3,150	122,2	59,2	112,2	ø23,5	40	M8X1,25	ø20	40	M8X1,25
XV-2R/30	3,400	130,2	63,2	120,2	ø23,5	40	M8X1,25	ø20	40	M8X1,25
XV-2R/34	3,600	137,2	66,7	127,2	ø23,5	40	M8X1,25	ø20	40	M8X1,25
XV-2R/40	3,800	146,2	71,2	136,2	ø23,5	40	M8X1,25	ø20	40	M8X1,25

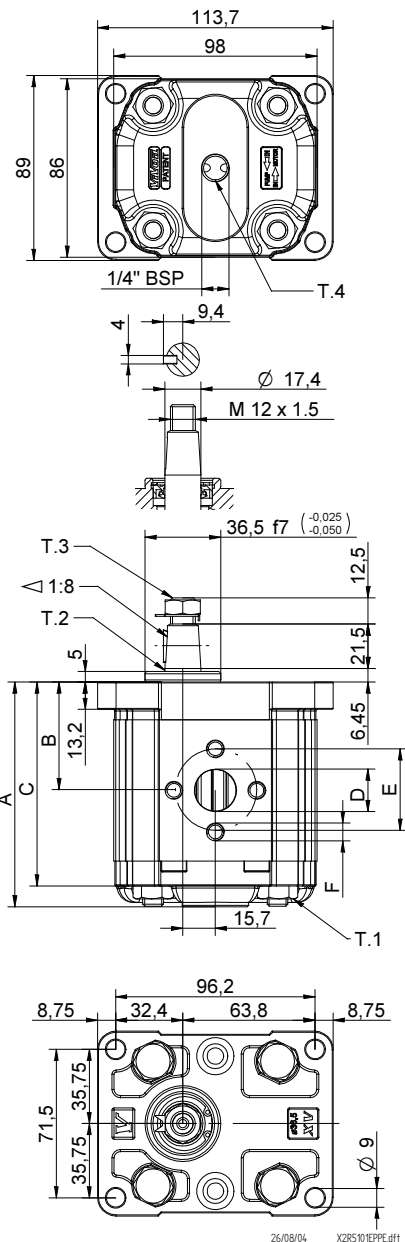

T.1 = 54÷58.9 [Nm] - screw tightening torque M10

T.3 = 40 [Nm] - torque wrench setting 19

T.2 = 233.2 [Nm] - admissible shaft torque (N.B. When choosing a shaft, always check the admissible torque).

T.4 = 0.3÷0.5 bar - max. drainage pressure

# Table of variations

# XV-2R

## ø36.5 FLANGE

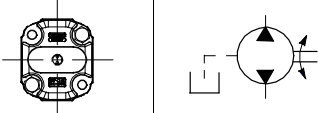
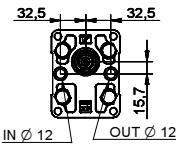
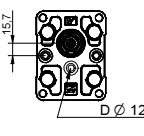
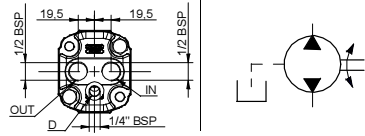
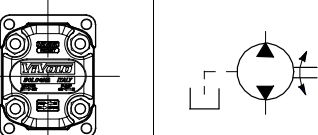
ø36.5 FLANGE		Shaft				Cover	
	01	CI001 - Parallel T.2 = 44.1 [Nm]	A	CI002 - Parallel T.2 = 67.5 [Nm]	B	 External drainage	E
		 32.5 32.5 15.7 IN Ø 12 OUT Ø 12	CO001 - Tapered T.2 = 233.2 [Nm]	E	CO002 - Tapered T.2 = 233.2 [Nm]		
 15.7 D Ø 12	05	SCF02 - Splined T.2 = 86.1 [Nm] m=1.6 Z=9 DIN 5482 - 17x14	G	SCF03 - Splined T.2 = 86.1 [Nm] m=1.6 Z=9 DIN 5482 - 17x14	H	 IN + OUT + external	K
		SCF04 - Splined T.2 = 67.1 [Nm] SAE J 498 9T 16/32 DP	I	SCF01 - Splined T.2 = 86.2 [Nm] m=1.6 Z=9 DIN 5482 - 17x14	L		
						 Flange drainage	P

Displacement	
TYPE	CODE
XV-2R/04	41
XV-2R/06	43
XV-2R/09	45
XV-2R/11	47
XV-2R/14	49
XV-2R/17	51
XV-2R/19	53
XV-2R/22	55
XV-2R/26	57
XV-2R/30	59
XV-2R/34	61
XV-2R/40	63

Displacement cm <sup>3</sup> /rev	Standard bodies			
	Standard threads			
4	O - O	R - R	B - B	Z - Z
6	O - O	R - R	B - B	Z - Z
9	O - O	R - R	B - B	Z - Z
11	O - O	R - R	B - B	Z - Z
14	P - P	R - R	C - C	Z - Z
17	P - P	R - R	C - C	Z - Z
19	P - P	R - R	C - C	Z - Z
22	P - P	R - R	C - C	Z - Z
26	Q - P	S - S	D - D	Z - Z
30	Q - P	S - S	D - D	Z - Z
34	Q - P	S - S	D - D	Z - Z
40	Q - P	S - S	D - D	Z - Z

Table showing standard flange and thread combinations available in stock

Body (threads/flanges)													
	A		B		C		D		E		F		G
	H		I		L		M		N		O		P
	Q		R		S		T		U		V	Closed Body	Z