

# reversible pump - series XV

# XV-2R

STANDARD EUROPEAN PUMP  
 ø36.5 FLANGE - TAPER SHAFT

**X 2 R 51 01 E C C E**

Series	X	series XV
Group	2	group 2
Category	R	reversible pump
Displacement	51	17
Flange	01	Ø36.5 STANDARD EUROPEAN reversible rotation
Shaft	E	CO001 - Tapered 1:8 - ø17.4 - M12x1.5 - key thk.4
Body	IN	inlet - 3/4" GAS
	OUT	outlet - 3/4" GAS
Cover	E	with external drainage



XR207

Technical data table

TYPE	Displacement cm3/rev	Max. Pressure		CODE	
		P1 bar	P3 bar	External drainage	Internal drainage
XV-2R/04	4,20	260	300	X 2 R 41 01 E B B E	X 2 R 41 01 E B B F
XV-2R/06	6,00	260	300	X 2 R 43 01 E B B E	X 2 R 43 01 E B B F
XV-2R/09	8,40	260	300	X 2 R 45 01 E B B E	X 2 R 45 01 E B B F
XV-2R/11	10,80	260	300	X 2 R 47 01 E B B E	X 2 R 47 01 E B B F
XV-2R/14	14,40	250	290	X 2 R 49 01 E C C E	X 2 R 49 01 E C C F
XV-2R/17	16,80	230	270	X 2 R 51 01 E C C E	X 2 R 51 01 E C C F
XV-2R/19	19,20	210	250	X 2 R 53 01 E C C E	X 2 R 53 01 E C C F
XV-2R/22	22,80	200	240	X 2 R 55 01 E C C E	X 2 R 55 01 E C C F
XV-2R/26	26,20	170	210	X 2 R 57 01 E D D E	X 2 R 57 01 E D D F
XV-2R/30	30,00	160	200	X 2 R 59 01 E D D E	X 2 R 59 01 E D D F
XV-2R/34	34,20	150	190	X 2 R 61 01 E D D E	X 2 R 61 01 E D D F
XV-2R/40	39,60	140	180	X 2 R 63 01 E D D E	X 2 R 63 01 E D D F

P1) Max. working pressure - P3) Max. peak pressure

For heavy-duty applications, it is recommended to check the admissible torque of the shaft

Dimensions table

TYPE	Weight kg	A	B	C	D	D
		mm	mm	mm	IN	OUT
XV-2R/04	2,200	87,2	41,7	77,2	1/2" BSPP	1/2" BSPP
XV-2R/06	2,300	90,2	43,2	80,2	1/2" BSPP	1/2" BSPP
XV-2R/09	2,400	94,2	45,2	84,2	1/2" BSPP	1/2" BSPP
XV-2R/11	2,500	98,2	47,2	88,2	1/2" BSPP	1/2" BSPP
XV-2R/14	2,700	104,2	50,2	94,2	3/4" BSPP	3/4" BSPP
XV-2R/17	2,800	108,2	52,2	98,2	3/4" BSPP	3/4" BSPP
XV-2R/19	2,900	112,2	54,2	102,2	3/4" BSPP	3/4" BSPP
XV-2R/22	3,050	118,2	57,2	108,2	3/4" BSPP	3/4" BSPP
XV-2R/26	3,150	122,2	59,2	112,2	1" BSPP	1" BSPP
XV-2R/30	3,400	130,2	63,2	120,2	1" BSPP	1" BSPP
XV-2R/34	3,600	137,2	66,7	127,2	1" BSPP	1" BSPP
XV-2R/40	3,800	146,2	71,2	136,2	1" BSPP	1" BSPP

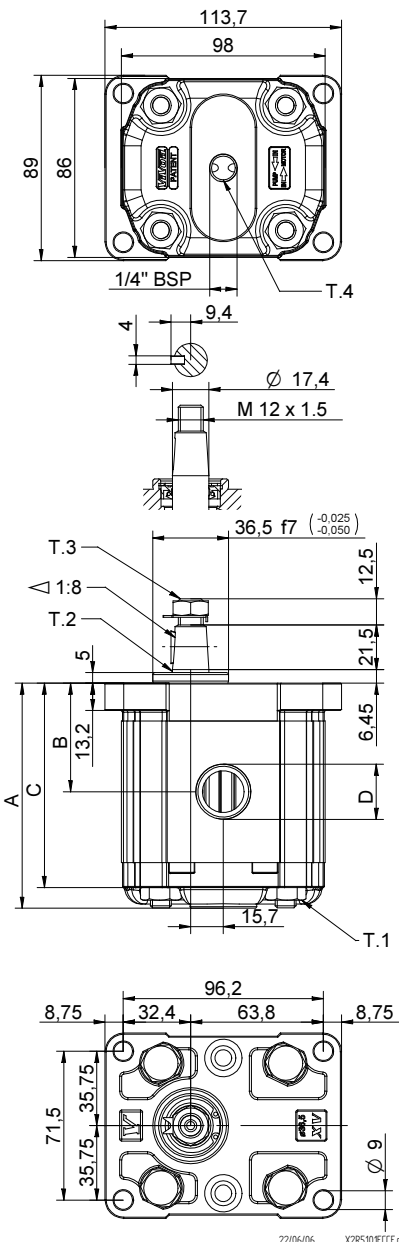

T.1 = 54÷58.9 [Nm] - screw tightening torque M10

T.3 = 40 [Nm] - torque wrench setting 19

T.2 = 233.2 [Nm] - admissible shaft torque (N.B. When choosing a shaft, always check the admissible torque).

T.4 = 0.3÷0.5 bar - max. drainage pressure

# Table of variations

# XV-2R

## ø36.5 FLANGE

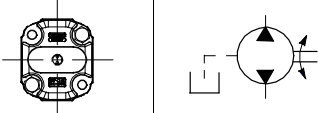
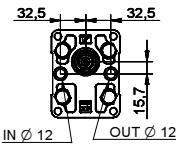
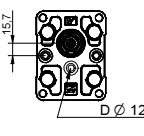
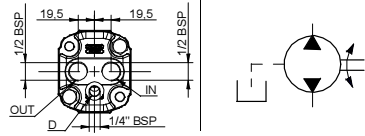
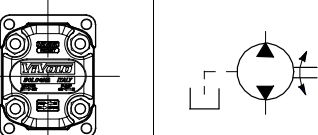
ø36.5 FLANGE		Shaft				Cover	
	01	CI001 - Parallel T.2 = 44.1 [Nm]	A	CI002 - Parallel T.2 = 67.5 [Nm]	B	 External drainage	E
		 IN Ø 12 OUT Ø 12	CO001 - Tapered T.2 = 233.2 [Nm]	E	CO002 - Tapered T.2 = 233.2 [Nm]		
 D Ø 12	05	SCF02 - Splined T.2 = 86.1 [Nm] m=1.6 Z=9 DIN 5482 - 17x14	G	SCF03 - Splined T.2 = 86.1 [Nm] m=1.6 Z=9 DIN 5482 - 17x14	H	 IN + OUT + external	K
		SCF04 - Splined T.2 = 67.1 [Nm] SAE J 498 9T 16/32 DP	I	SCF01 - Splined T.2 = 86.2 [Nm] m=1.6 Z=9 DIN 5482 - 17x14	L		
						 Flange drainage	P

Displacement	
TYPE	CODE
XV-2R/04	41
XV-2R/06	43
XV-2R/09	45
XV-2R/11	47
XV-2R/14	49
XV-2R/17	51
XV-2R/19	53
XV-2R/22	55
XV-2R/26	57
XV-2R/30	59
XV-2R/34	61
XV-2R/40	63

Displacement cm <sup>3</sup> /rev	Standard threads			
	O - O	R - R	B - B	Z - Z
4	O - O	R - R	B - B	Z - Z
6	O - O	R - R	B - B	Z - Z
9	O - O	R - R	B - B	Z - Z
11	O - O	R - R	B - B	Z - Z
14	P - P	R - R	C - C	Z - Z
17	P - P	R - R	C - C	Z - Z
19	P - P	R - R	C - C	Z - Z
22	P - P	R - R	C - C	Z - Z
26	Q - P	S - S	D - D	Z - Z
30	Q - P	S - S	D - D	Z - Z
34	Q - P	S - S	D - D	Z - Z
40	Q - P	S - S	D - D	Z - Z

Table showing standard flange and thread combinations available in stock

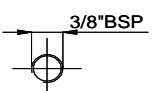
Body (threads/flanges)													
	A		B		C		D		E		F		G
	H		I		L		M		N		O		P
	Q		R		S		T		U		V	Closed Body 	Z