



**160**  
kN



**-130**  
kN



**80**  
kN

**-65**  
kN

**3400**  
nm

**65**  
kg

**40**  
l/min

Hydraulic rotator FHR 16FD1 designed for heavy duty machinery to meet the highest demands for quality and reliability. Ideal for intensive professional use in forestry, agriculture, road and building construction, recycling industry, general cargo and material handling.

Rotator's upper mount is applied in FORK form factor of the knuckle joint. Robust and tough built to withstand even overloads. The fork width (between fork ends) is common standard width 100mm and the knuckle pin diameter 45mm.



FHL 03

Rotator lower mount is applied in FLANGE form factor to mount direct on grapple / tool surface by fixing with screws

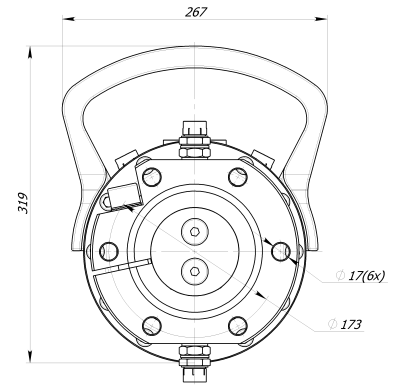
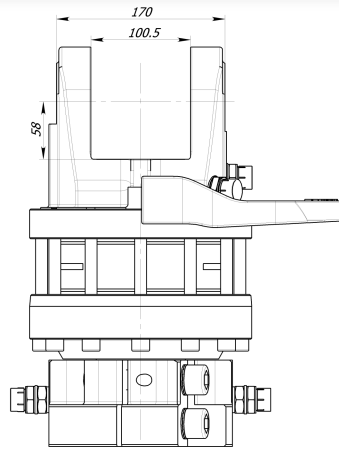
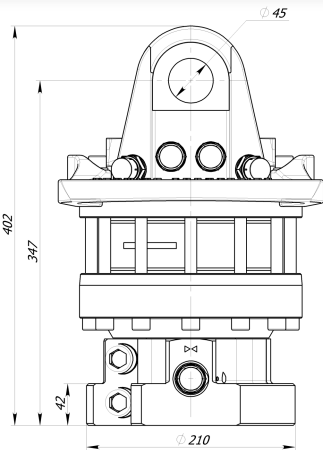



On request by special conditions there are metric nipples available for rotator FHR 16FD1

FORESTRY GENERAL CARGO AGRICULTURE CONSTRUCTION RECYCLING





Hydraulic rotator FHR 16FD1 designed for heavy duty machinery to meet the highest demands for quality and reliability. Ideal for intensive professional use in forestry, agriculture, road and building construction, recycling industry, general cargo and material handling.

 Rotator's upper mount is applied in FORK form factor of the knuckle joint. Robust and tough built to withstand even overloads. The fork width (between fork ends) is common standard width 100mm and the knuckle pin diameter 45mm.

 Rotator lower mount is applied in FLANGE form factor to mount direct on grapple / tool surface by fixing with screws

 Rotator FHR 16FD1 based on reliable vane type hydraulic motor which delivers torque up to 3400Nm at 25MPa.

 Formiko Hydraulics rotator FHR 16FD1 is equipped with double bearings to withstand both tensional and pushing loads.

 Formoko rotator FHR 16FD1 is compatible with FHL 03 series links.

 Rotator for shipping is packed in compact solid cardboard box with dimensions 450x250x250mm.

 We providing TWO year warranty for this rotator.

On request by special conditions there are metric nipples available for rotator FHR 16FD1

