









45 kN						
22.5 kN	L73 \varnothing 25 mm	3/8" BSP	250 bar	3/8" BSP	200 bar	300 bar
1200 nm						
24 kg						
20 l/min						

Rotator's upper mount is applied in EYE form factor of the knuckle joint. Robust and tough built to withstand even overloads. The wide of eye is common standard width 73mm and the knuckle pin diameter 25mm.

Hydraulic rotator FHR 4.500L is cost-effective solution generally for seasonal use in forestry, agriculture, road and building construction, general cargo and material handling.



Rotator lower mount is applied in AXLE form factor to mount in grapple / tool mounting tube or adaptor and by fixing with pin. Axle (shaft) diameter is 59mm and the fixing pin (not included) diameter 30mm

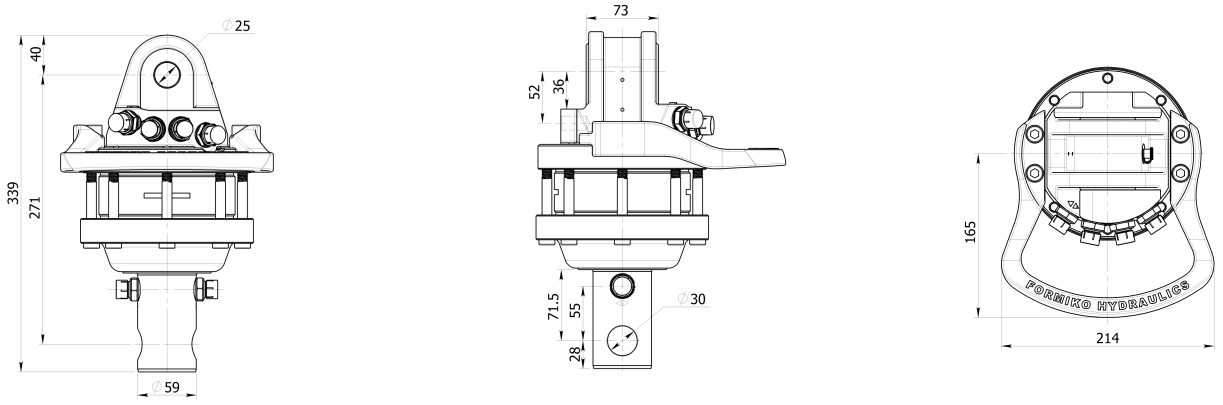
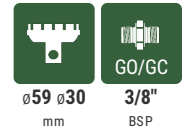

On request by special conditions there are metric nipples available for rotator FHR 4.500L



Hydraulic rotator FHR 4.500L is cost-effective solution generally for seasonal use in forestry, agriculture, road and building construction, general cargo and material handling.



Rotator's upper mount is applied in EYE form factor of the knuckle joint. Robust and tough built to withstand even overloads. The wide of eye is common standard width 73mm and the knuckle pin diameter 25mm.



Rotator lower mount is applied in AXLE form factor to mount in grapple / tool mounting tube or addaptor and by fixing with pin. Axle (shaft) diameter is 59mm and the fixing pin (not included) diameter 30mm



Rotator FHR 4.500L based on reliable vane type hydraulic motor which delivers torque up to 1200Nm at 25MPa.



Fomoko rotator FHR 4.500L is compatible with FHL 01-A/B-73/25 and FHL 01B-A/B-73/25 series links.



Rotator for shipping is packed in compact solid cardboard box with dimensions 340x230x240mm.



We providing TWO year warranty for this rotator.

On request by special conditions there are metric nipples available for rotator FHR 4.500L

FORESTRY GENERAL CARGO AGRICULTURE CONSTRUCTION

