

HNV brass



Standard couplings for industrial applications, ISO 7241-B interchange, brass versions

Standard couplings for industrial applications with brass components. Available with NBR or Viton seals. ISO 7241 part B interchange.

Applications

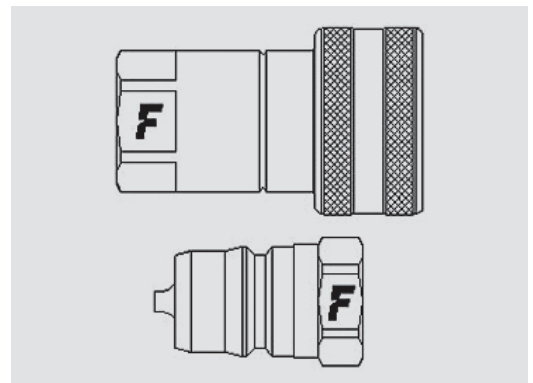

Technical Specifications

dash	Size mm	inch	Working Pressure (MPa)	Flow Rate (l/min)	Spillage (ml)	Force to Connect (N)	Burst pressure (MPa)		
							Male	Female	Male + Female
02	3,2	1/8"	22	6	0,5	110	90	140	150
04	6,3	1/4"	20	16	1	75	80	120	120
06	10	3/8"	15	25	1,5	78	60	70	100
08	12,5	1/2"	17	60	2,8	97	70	90	90
12	20	3/4"	10	110	10	180	40	50	100
16	25	1"	14	150	13	180	56	58	80
24	37,5	1-1/2"	7	750	80	185	30	33	40

Material	Brass
Seals	NBR; VITON*
Working temperatures	- 25 °C to + 125 °C
Surface treatment	
Series Interchange	ISO 7241-B
Valve Type	Poppet
Connection	Sleeve Retraction
Disconnection	Sleeve Retraction
Connection Under Pressure	Not Allowed

* Working temperatures: - 20 °C to + 200 °C

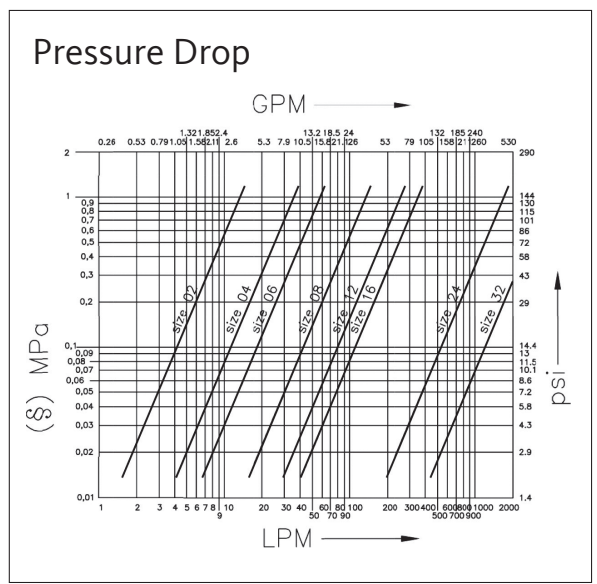

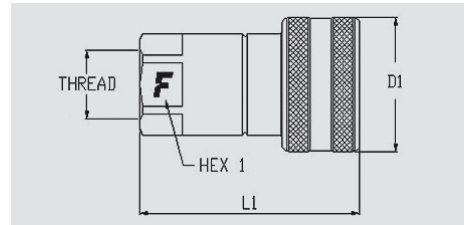

HNV brass

Size		Thread details			FEMALE						
inch	mm	Thread Type	Standard	Thread	Part Number	L (L1 + Thread)		D1		HEX1	
						mm	inch	mm	inch	mm	inch
1/8"	3,2	F BSPP	ISO 1179-1	BSPP 1/8 FEMALE	HNV 18 GAS F 5	50	1,97	23	0,91	18	0,71
1/8"	3,2	F BSPP	ISO 1179-1	BSPP 1/8 FEMALE	HNV 18 GAS F 5V	50	1,97	23	0,91	18	0,71
1/8"	3,2	F NPTF	ANSI B1.20.3	NPTF 1/8 FEMALE	HNV 18 NPT F 5	50	1,97	23	0,91	18	0,71
1/8"	3,2	F NPTF	ANSI B1.20.3	NPTF 1/8 FEMALE	HNV 18 NPT F 5V	50	1,97	23	0,91	18	0,71
1/4"	6,3	F BSPP	ISO 1179-1	BSPP 1/4 FEMALE	HNV 14 GAS F 5	56	2,2	28	1,1	19	0,75
1/4"	6,3	F BSPP	ISO 1179-1	BSPP 1/4 FEMALE	HNV 14 GAS F 5V	56	2,2	28	1,1	19	0,75
1/4"	6,3	F NPTF	ANSI B1.20.3	NPTF 1/4 FEMALE	HNV 14 NPT F 5	56	2,2	28	1,1	19	0,75
1/4"	6,3	F NPTF	ANSI B1.20.3	NPTF 1/4 FEMALE	HNV 14 NPT F 5V	56	2,2	28	1,1	19	0,75
3/8"	10	F BSPP	ISO 1179-1	BSPP 3/8 FEMALE	HNV 38 GAS F 5	64	2,52	35	1,38	24	0,94
3/8"	10	F BSPP	ISO 1179-1	BSPP 3/8 FEMALE	HNV 38 GAS F 5V	64	2,52	35	1,38	24	0,94
3/8"	10	F NPTF	ANSI B1.20.3	NPTF 3/8 FEMALE	HNV 38 NPT F 5	64	2,52	35	1,38	24	0,94
3/8"	10	F NPTF	ANSI B1.20.3	NPTF 3/8 FEMALE	HNV 38 NPT F 5V	64	2,52	34	1,34	24	0,94
1/2"	12,5	O/ SAE	ISO 11926-1	3/4"-16 UNF FEMALE ORB	HNV 12-12SAE FS	71,5	2,81	44	1,73	30	1,18
1/2"	12,5	O/ SAE	ISO 11926-1	3/4"-16 UNF FEMALE ORB	HNV 12-12SAEF5V	71,5	2,81	44	1,73	30	1,18
1/2"	12,5	F BSPP	ISO 1179-1	BSPP 1/2 FEMALE	HNV 12 GAS F 5	71,6	2,82	44	1,73	30	1,18
1/2"	12,5	F BSPP	ISO 1179-1	BSPP 1/2 FEMALE	HNV 12 GAS F 5V	71,6	2,82	44	1,73	30	1,18
1/2"	12,5	F NPTF	ANSI B1.20.3	NPTF 1/2 FEMALE	HNV 12 NPT F 5	71,5	2,81	44	1,73	30	1,18
1/2"	12,5	F NPTF	ANSI B1.20.3	NPTF 1/2 FEMALE	HNV 12 NPT F 5V	71,5	2,81	44	1,73	30	1,18
3/4"	20	F BSPP	ISO 1179-1	BSPP 3/4 FEMALE	HNV 34 GAS F 5	89	3,5	52	2,05	36	1,42
3/4"	20	F BSPP	ISO 1179-1	BSPP 3/4 FEMALE	HNV 34 GAS F 5V	89	3,5	52	2,05	36	1,42
3/4"	20	F NPTF	ANSI B1.20.3	NPTF 3/4 FEMALE	HNV 34 NPT F 5	89	3,5	52	2,05	36	1,42
3/4"	20	F NPTF	ANSI B1.20.3	NPTF 3/4 FEMALE	HNV 34 NPT F 5V	89	3,5	52	2,05	36	1,42
1"	25	F BSPP	ISO 1179-1	BSPP 1 FEMALE	HNV 1 GAS F 5	106	4,17	62	2,44	41	1,61
1"	25	F BSPP	ISO 1179-1	BSPP 1 FEMALE	HNV 1 GAS F 5V	106	4,17	62	2,44	41	1,61
1"	25	F NPTF	ANSI B1.20.3	NPTF 1 FEMALE	HNV 1 NPT F 5	106	4,17	62	2,44	41	1,61
1"	25	F NPTF	ANSI B1.20.3	NPTF 1 FEMALE	HNV 1 NPT F 5V	106	4,17	62	2,44	41	1,61
1-1/2"	37,5	F BSPP	ISO 1179-1	BSPP 1-1/2 FEMALE	HNV112 GAS F 5	126	4,96	75	2,95	65	2,56
1-1/2"	37,5	F BSPP	ISO 1179-1	BSPP 1-1/2 FEMALE	HNV112 GAS F5V	126	4,96	75	2,95	65	2,56
1-1/2"	37,5	F NPTF	ANSI B1.20.3	NPTF 1-1/2 FEMALE	HNV112 NPT F 5	126	4,96	75	2,95	65	2,56

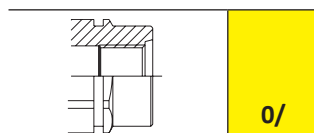
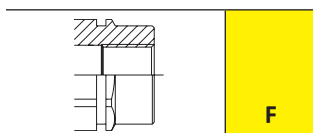

HNV brass

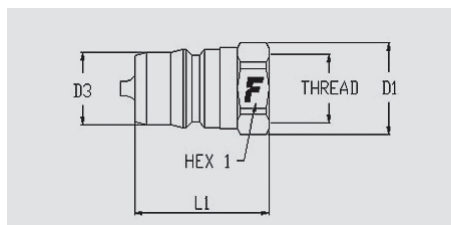

Size		Thread details			MALE									
inch	mm	Thread Type	Standard	Thread	Part Number	L (L1 + Thread)		D1		D3		HEX1		
						mm	inch	mm	inch	mm	inch	mm	inch	
1/8"	3,2	F BSPP	ISO 1179-1	BSPP 1/8 FEMALE	HNV 18 GAS M 5	31,5	1,24	18	0,71	10,8	0,43	18	0,71	
1/8"	3,2	F BSPP	ISO 1179-1	BSPP 1/8 FEMALE	HNV 18 GAS M 5V	31,5	1,24	18	0,71	10,8	0,43	18	0,71	
1/8"	3,2	F NPTF	ANSI B1.20.3	NPTF 1/8 FEMALE	HNV 18 NPT M 5	31,5	1,24	18	0,71	10,8	0,43	16	0,63	
1/8"	3,2	F NPTF	ANSI B1.20.3	NPTF 1/8 FEMALE	HNV 18 NPT M 5V	31,5	1,24	18	0,71	10,8	0,43	16	0,63	
1/4"	6,3	F BSPP	ISO 1179-1	BSPP 1/4 FEMALE	HNV 14 GAS M 5	35	1,38	21	0,83	14,1	0,56	19	0,75	
1/4"	6,3	F BSPP	ISO 1179-1	BSPP 1/4 FEMALE	HNV 14 GAS M 5V	35	1,38	21	0,83	14,1	0,56	19	0,75	
1/4"	6,3	F METRIC	ISO 9974-1	M12x1 FEMALE	HNV 14-1210 M5V	35	1,38	21	0,83	14,1	0,56	19	0,75	
1/4"	6,3	F NPTF	ANSI B1.20.3	NPTF 1/4 FEMALE	HNV 14 NPT M 5	35	1,38	21	0,83	14,1	0,56	19	0,75	
1/4"	6,3	F NPTF	ANSI B1.20.3	NPTF 1/4 FEMALE	HNV 14 NPT M 5V	35	1,38	21	0,83	14,1	0,56	19	0,75	
3/8"	10	F BSPP	ISO 1179-1	BSPP 3/8 FEMALE	HNV 38 GAS M 5	39	1,54	24,5	0,96	19	0,75	24	0,94	
3/8"	10	F BSPP	ISO 1179-1	BSPP 3/8 FEMALE	HNV 38 GAS M 5V	39	1,54	24,5	0,96	19	0,75	22	0,87	
3/8"	10	F NPTF	ANSI B1.20.3	NPTF 3/8 FEMALE	HNV 38 NPT M 5	39	1,54	24,5	0,96	19	0,75	22	0,87	
3/8"	10	F NPTF	ANSI B1.20.3	NPTF 3/8 FEMALE	HNV 38 NPT M 5V	39	1,54	24,5	0,96	19	0,75	22	0,87	
1/2"	12,5	F BSPP	ISO 1179-1	BSPP 1/2 FEMALE	HNV 12 GAS M 5	44	1,73	30	1,18	23,5	0,93	27	1,06	
1/2"	12,5	F BSPP	ISO 1179-1	BSPP 1/2 FEMALE	HNV 12 GAS M 5V	44	1,73	30	1,18	23,5	0,93	27	1,06	
1/2"	12,5	F NPTF	ANSI B1.20.3	NPTF 1/2 FEMALE	HNV 12 NPT M 5	44	1,73	30	1,18	23,5	0,93	27	1,06	
1/2"	12,5	F NPTF	ANSI B1.20.3	NPTF 1/2 FEMALE	HNV 12 NPT M 5V	44	1,73	30	1,18	23,5	0,93	27	1,06	
3/4"	20	F BSPP	ISO 1179-1	BSPP 3/4 FEMALE	HNV 34 GAS M 5	55	2,17	38	1,5	31,5	1,24	34	1,34	
3/4"	20	F BSPP	ISO 1179-1	BSPP 3/4 FEMALE	HNV 34 GAS M 5V	55	2,17	38	1,5	31,5	1,24	34	1,34	
3/4"	20	F NPTF	ANSI B1.20.3	NPTF 3/4 FEMALE	HNV 34 NPT M 5	55	2,17	38	1,5	31,5	1,24	34	1,34	
3/4"	20	F NPTF	ANSI B1.20.3	NPTF 3/4 FEMALE	HNV 34 NPT M 5V	55	2,17	38	1,5	31,5	1,24	34	1,34	
1"	25	F BSPP	ISO 1179-1	BSPP 1 FEMALE	HNV 1 GAS M 5	66	2,6	45	1,77	37,8	1,49	41	1,61	
1"	25	F BSPP	ISO 1179-1	BSPP 1 FEMALE	HNV 1 GAS M 5V	66	2,6	45	1,77	37,8	1,49	41	1,61	
1"	25	F NPTF	ANSI B1.20.3	NPTF 1 FEMALE	HNV 1 NPT M 5V	66	2,6	45	1,77	37,8	1,49	41	1,61	
1-1/2"	37,5	F BSPP	ISO 1179-1	BSPP 1-1/2 FEMALE	HNV112 GAS M 5	123,5	4,86	70	2,76	44,5	1,75	65	2,56	
1-1/2"	37,5	F BSPP	ISO 1179-1	BSPP 1-1/2 FEMALE	HNV112 GAS M 5V	123,5	4,86	70	2,76	44,5	1,75	65	2,56	
1-1/2"	37,5	F NPTF	ANSI B1.20.3	NPTF 1-1/2 FEMALE	HNV112 NPT M 5	123,5	4,86	70	2,76	44,5	1,75	65	2,56	

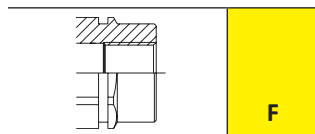

HNV brass accessories

PVC dust caps



Plugs suitable for FEMALE



Caps suitable for MALE

Size			Plug Details		Size			Cap Details	
inch	mm	dash	Part number	Colour	inch	mm	dash	Part number	Colour
1/8"	3,2	02	TMH 18	red	1/8"	3,2	02	TFH 18	red
1/4"	6,3	04	TMH 14	red	1/4"	6,3	04	TFH 14	red
1/4"	6,3	04	TMH 14 N	black	1/4"	6,3	04	TFH 14 N	black
3/8"	10	06	TMH 38	red	3/8"	10	06	TFH 38	red
3/8"	10	06	TMH 38 A	orange	3/8"	10	06	TFH 38 A	orange
3/8"	10	06	TMH 38 B	blue	3/8"	10	06	TFH 38 B	blue
3/8"	10	06	TMH 38 G	yellow	3/8"	10	06	TFH 38 G	yellow
1/2"	12,5	08	TMH 12	red	3/8"	10	06	TFH 38 N	black
3/4"	20	12	TMH 34	red	1/2"	12,5	08	TFH 12	red
3/4"	20	12	TMH 34 N	black	3/4"	20	12	TFH 34	red
1"	25	16	TMH 1	red	3/4"	20	12	TFH 34 N	black
					1"	25	16	TFH 1	red

Aluminium dust caps



Plugs suitable for FEMALE



Caps suitable for MALE

Size			Plug Details		Size			Cap Details	
inch	mm	dash	Part number	Colour	inch	mm	dash	Part number	Colour
1/8"	3,2	02	TMH 18 S		1/8"	3,2	2	TFH 18 S	
1/4"	6,3	04	TMH 14 S		1/4"	6,3	4	TFH 14 S	
1-1/2"	37,5	24	TMH112 S		1-1/2"	37,5	24	TFH112 S	

Seal Kits



For Female

Size			Seal Details	
inch	mm	dash	Material	Part Number
1/8"	3,2	02	NBR;PTFE	SK HNV 18
1/8"	3,2	02	FKM;PTFE	SK HNV 18 V
1/4"	6,3	04	NBR;PTFE	SK HNV 14
1/4"	6,3	04	FKM;PTFE	SK HNV 14 V
3/8"	10	06	NBR;PTFE	SK HNV 38
3/8"	10	06	FKM;PTFE	SK HNV 38 V
1/2"	12,5	08	NBR;PTFE	SK HNV 12
1/2"	12,5	08	NBR;PTFE	SK HNV 12 V
3/4"	20	12	NBR;PTFE	SK HNV 34
3/4"	20	12	FKM;PTFE	SK HNV 34 V
1"	25	16	NBR;PTFE	SK HNV 1
1"	25	16	FKM;PTFE	SK HNV 1 V
1-1/2"	37,5	24	NBR	SK HNV 112
1-1/2"	37,5	24	FKM	SK HNV 112 V
2"	50	32	FKM	SK HNV 2 V

Every seals kit is composed of 5 or 10 pcs.